

# The Montana Consumer Guide to Solar Heating Systems



- ⚙ Solar Heating Overview
- ⚙ Passive Solar Applications
- ⚙ Solar Heated Air Systems
- ⚙ Solar Hot Water Systems
- ⚙ Tax Credits/Financing

# **The Montana Consumer Guide to Solar Heating Systems**

## **Understanding and Incorporating Solar Heating for Residential and Small-Business Consumers**

Thank you for your interest in solar heat, and for taking the time to read this publication. It has been developed as a basic resource and practical guide for consumers who want to learn more about and incorporate solar heat into their home or small-business.

The publication highlights the basics of solar heating technologies that have been successfully installed in Montana. It is not intended to be a technical manual, and consumers should research and have an understanding of the specific heating application before incorporating it into either new or existing buildings.

Montana has a number of solar heating contractors in Montana, as well as architectural firms with experience in passive solar design. These companies are skilled in working with building and traditional heating contractors to incorporate solar heat into both new buildings and remodels.

**Developed by:**  
Highmark Media

**With Support, Input and Review by:**  
The Forward Current Foundation

**Acknowledgments:**  
Funding for the printing of this publication has been provided through Universal System Benefits (USB) funds collected from NorthWestern Energy customers.

The views and opinions expressed in this publication are those of the authors and do not necessarily reflect those of funders or any state agency.

Cover Photo Courtesy of 13 Mile Lamb and Wool Company - Belgrade, MT

**Printed January 2016**

# Table of Contents

## **Solar Heating Overview**

Introduction and Basics .....	2
Applicable Technologies.....	2
Heat and How It Is Transferred.....	2-3
Will Your Site Work? .....	3-4
Building Design and Solar Radiation.....	4
Assessing Your Site With Instrumentation .....	4

## **Passive Solar Applications**

Overview.....	4-5
Primary Design Considerations.....	5
Interior Spaces .....	5
Key Characteristics of Passive Solar Design .....	6
Direct Gain.....	6
Indirect Gain .....	6-7
Isolated Gain .....	7
Heat Transfer at the Window Space.....	8
Window Technologies, NFRC Ratings, U-Value or U-Factor .....	8-9
Solar Heat Gain Coefficient.....	9
Visible Transmittance, Air Leakage, Condensation Resistance .....	9

## **Solar Heated Air Systems**

Overview.....	9
Solar Heated Air Collectors.....	10
Transpired Collectors .....	10

## **Solar Hot Water Systems**

Overview.....	10
Flat Plate Collectors .....	10-11
Evacuated Tube Collectors .....	11-12
Advantages/Disadvantages of Collector Types.....	12
Solar Batch Collectors .....	12
Choices for Montana.....	12
Indirect Thermosiphon and Drainback Systems .....	13
Closed Loop Anti-Freeze Systems.....	14
System Components, Hot Water Storage Tanks.....	14
Heat Exchangers, Pumps, Pipes and Insulation, Solar Loop Fluid.....	15
Isolation and Tempering Valves.....	16

## **Available Tax Credits and Financing**

Federal Residential Solar Hot Water Heat Tax Credit.....	16
Montana Alternative Energy Systems Tax Credit .....	16
Montana Alternative Energy Revolving Loan Fund .....	16

# Solar Heating Overview

## Introduction and Basics

Did you know the solar heat you feel on your face on a summer's day has traveled approximately 93 million miles in just over eight minutes? The heat from the sun is called solar radiation, and it travels through the vacuum in space via electromagnetic waves, much like light.

In order for the radiant heat from the sun to be manifested, it must have a substance/surface to accept the infrared rays. The amount of heat radiation that is absorbed and realized depends on what is called the emissivity of the receptacle surface. For example, dark, coarse materials readily accept infrared waves and have a high emissivity (i.e. pavement, rocks), while white, smoother surfaces reflect much of the radiant energy and have a low emissivity.

The core of all solar heat types relies first and foremost on the ability of the specific system's collective surface to capture the desired amount of infrared radiation. The designs and components to accomplish this vary greatly and range from simple to complex – whether it be modest but well-placed south facing windows providing supplemental winter heat or engineered hot water, high-mass radiant systems, there is “something for everyone” interested in the technology.

## Applicable Technologies

For the purposes of this publication, the term “solar heat” includes three primary categories; solar heated air space heating, solar hot water space heating, and solar domestic water heating.

Space heating (either hot water or air) involves designs and components that have an end use of heating the interior spaces of a home or structure. Domestic hot water heating includes technologies that have an end use for applications requiring heated water (i.e. showers, washing clothes.) Some systems can be a combination of both solar hot water space and domestic hot water heating.

Solar heating systems are either classified as “active” or “passive.” The difference is quite simple. Active systems transfer or circulate water, solar fluid, or air using external pumps, fans or other motorized controls. Passive systems transfer or circulate water, solar fluid, or air without utilizing pumps, fans or other motorized controls. Instead, they usually take advantage of the physics of heat and heat movement to achieve the transfer.



Passive Solar Structure

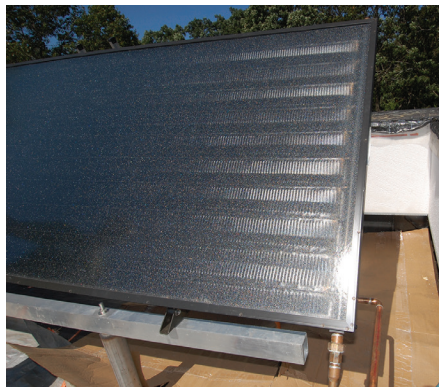

Flat Plate Hot Water System

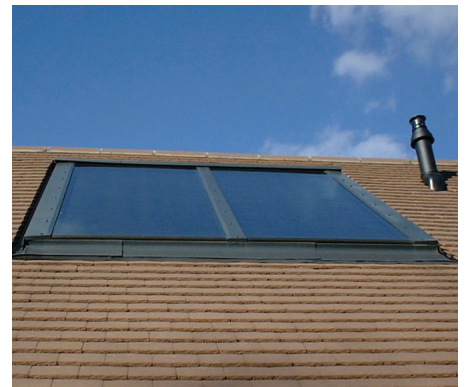

Integrated Heated Air System

## Heat and How It Is Transferred

Key to understanding the fundamentals and variables of solar heating systems is a basic comprehension of how heat is transferred. With this knowledge, consumers can make good choices about solar heating and better understand heat conservation methods and the specific thermal interactions that happen within their homes.

Heat is thermal energy that flows or moves from one body of matter to another. The second law of thermodynamics states that this transfer is always directional from higher to lower temperature and will continue until there is no longer a difference between the two different sources. Although there are isolated exceptions, if a structure's environment is viewed as a constant interaction whereby the warmest molecules within the home are constantly working to transfer heat to cooler sources, the building's heating and cooling interactions can be more easily understood.

There are three methods by which heat is transferred: convection, conduction and radiation. A working knowledge of these methods is central to choosing a suitable solar heating application.

Convection takes place when the motion of a gas or liquid carries energy from a warmer source to a cooler source. Circulation is a representation of convection. Convection can take place through two scenarios: natural and forced.



The motion of hot air is an example of natural convection. Because hot air has a lower density than the cooler air in the atmosphere, it is buoyant. As hot air rises, it soon loses energy and cools. The cooled air, which reaches a point denser than the air around it, sinks downward.

Forced convection is the result of heated air or fluid being moved by mechanical means (i.e. a pump or a fan). Within a room or enclosure with heat provided by, for example, a forced air furnace, there is both natural and forced convection occurring within the space. A heating system working full force to bring a cold room up to temperature relies primarily on forced convection, and when the room reaches the desired temperature, the natural convection process occurs.

Convection is also important to remember regarding insulation and the integrity of a structure's shell. Heated air from within a house always has the potential to want to transfer its energy to cooler sources. Leaks and colder un-insulated spaces can rapidly become channels for interior air to find its way outside.

Conduction involves the transfer of heat between two bodies or substances with a temperature differential that are in physical contact with one another. A good example of this is the instance of placing a metal object in fire. The object will change color and become "red hot," as heat from the fire is transferred along the length of the metal.

Preventing active conduction is the rationale for properly insulating a home. Insulation is designed to be a poor conductor and prevents natural elements and heat from sources such as hot shingles and structural materials from being conducted into the house. Insulation also provides a buffer that prevents molecular interaction between the materials in a warm home interior and colder material outside.

Radiation is distinguished from both convection and conduction in that there is no intervening medium required for its transfer. As discussed earlier in this publication, the obvious example of radiant energy is the heat provided by the sun. Radiant energy travels in a vacuum (space) until it reaches a source that can absorb it (the earth). But it remains radiation (which is electromagnetic) and isn't manifested as heat until it is absorbed into the earth's atmosphere. This accounts for the significantly lower temperatures in space compared to earth.

In a man-made environment, good examples of heat from infrared radiation are the warmth from a fireplace or the heat radiated from an incandescent light bulb. Although the radiant heat in a home eventually becomes a part of either or both convection and conduction cycles, in its pure form it simply radiates until it can find an object which will absorb it.



Radiant Heat

## Will Your Site Work?

Direct interaction and the ability to capture solar radiation is essential for any type of solar heating. In order to accomplish this, the design and system components must be orientated correctly. This also includes designs and devices to "block" or mitigate the sunlight when it is not needed (i.e. window shades or solar hot water shunt valves.)

There are three critical factors that determine the amount of solar radiation available to the collecting receptacle(s) at a specific solar heating site.

The **first factor** is that the total surface area of the collection apparatus (solar collector, windows) determines the amount of solar radiation that can be absorbed and made available for the solar heating system.

The **second factor** is that absorbed radiation is directly dependent on the angle between the collector (or window) and the sun.

At 25 degrees from perpendicular to the sun, 90 percent of solar radiation is still available to be absorbed. From there, the percentages drop in a linear pattern until 90 degrees, where zero percent of direct radiation is available for absorption.

The **third factor**, as already noted, is that the color and surface texture of the material will determine the amount of radiation that is absorbed or reflected. Highly polished surfaces such as mirrors reflect radiation, while rough textured surfaces will diffuse, rather than reflect, the sun's rays.

Dark colors absorb radiation the best. White, because it is a combination of all colors of the light spectrum, reflects nearly all solar radiation.



Passive Solar House Under Construction

Clear glass is transparent and allows up to 85% of the radiation to pass through without reflecting or diffusing the sun's rays. One of the core elements of many solar hot water and air collector designs includes the use of a glass or other transparent outer covering, with an opaque surface underneath. This combination results in the "greenhouse effect" within the collector, whereby the trapped heat cannot radiate back out. It is utilized in either an intermediary or end use design.

## Building Design and Solar Radiation

For the majority of Montana's solar heat applications, the demand for heat is usually the greatest during the fall, winter, and early spring when the days are the shortest, although this is not necessarily true for consumers installing solar domestic hot water systems, where usage patterns are fairly consistent throughout the year.

With this in mind, consider that in northern latitudes, the south side of a building receives nearly three times as much winter solar radiation when compared to the east and west side of the buildings.

In summer, the south side receives considerably less radiation, and the east and west sides have higher solar gain. During all seasons, the north side receives minimal radiation.

The ideal building design, especially for passive solar heating applications, is a structure that is elongated along the east-west axis. This design ensures that the south side is exposed to the winter sun for the longest time period, but just as importantly, it means that the east and west sides are exposed to the highest percentage of heat gain during the summer months when the sun is not wanted on the south side.

The north side of a house on an east/west axis can be a considerable source of heat loss and/or infiltration. Window and access points should be minimized, and protection from north winds provided through the use of trees, shrubs and garages or outbuildings.

Also consider that excessive outside surface areas created by non-traditional designs will have an impact on the inside temperature of the home.

## Assessing Your Site With Instrumentation

Most consumers can perform a visual assessment of their structure's site, but a professional solar heat dealer/installer has specific instrumentation to make a calculated assessment of your site.

Devices such as the Solar Pathfinder® give an accurate assessment of the sun's path as it impacts the specific area where the home's collector(s) are proposed to be mounted.

The dealer/installer can use the instrumentation to calculate specific orientation and estimate the sun's path throughout the year. This is also useful in determining obstructions from trees or other buildings. The Solar Pathfinder® also works well for passive solar applications and window placement for new construction. Obstacles such as nearby buildings or trees can be accounted for prior to construction.

Roof angles are also critical for solar performance. A professional installer/dealer can provide options for mounting collectors to optimize the solar profile at a specific site.

## Passive Solar Applications

### Overview

When in place, passive solar heating is the most cost effective way to heat a structure. In Montana, passive solar is an effective way to reduce the use of a home's traditional heating system, especially during the winter months.

Experts point to the fact that approximately 25% of residential heating and cooling energy in America is based on the need for specific space heating or cooling due to limits in the siting and design characteristics of homes. Throughout most of the 20th century, the orientation and design of critical home components, most notably windows, did not include characteristics that optimized or controlled solar gain within the structure.

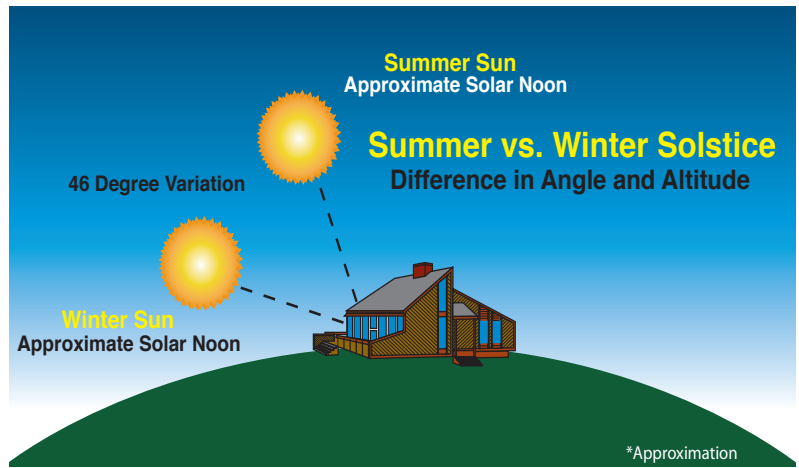

Passive solar systems incorporate a combination of building components to reduce or sometimes eliminate mechanical heating and/or cooling, as well as supplement structural lighting. It is predicated on using a home's windows, floors and walls to collect, store and distribute heat. A well-designed building also incorporates summer sun characteristics and has controls to limit unwanted seasonal solar radiation.

“True” passive solar design doesn't utilize pumps or fans to circulate heat. Instead, the design incorporates glazing and construction materials that passively receive and release solar radiation. Most designs also take advantage of natural sunlight through designated windows and floor plans to illuminate the home's interior.

The majority of architectural plans can incorporate passive solar design, however there are some limitations with certain geometric designs. At its core, a well designed passive solar home is built to maximize and take advantage of the three types of heat transfer - convection, conduction and radiation.

## Primary Design Considerations

Effective passive solar homes are integrated and synergistic - design, construction and materials work in harmony to take advantage of available solar gain based on the home's geographical location and climate. In Montana, due to the extreme temperature variations resulting from the state's distinct seasons, passive solar design must address both winter and summer climate characteristics.

In addition to the “long axis” of the home designed to run from east to west, professionals recommend a number of general siting considerations for passive solar design. Although these considerations are primarily directed to new construction, they can also be incorporated to varying degrees during retrofits. They are:

The home has either a basement or is built into a hillside (or both). This reduces winter heat loss resulting from above grade walls and helps provide cooling from the earth during summer months.

When possible, the house is located on the southern or southwest slope of a hill to maximize winter solar potential and minimize summer sun.

Landscaping is planned to shade the home's south, southwest and southeast sides during summer months (deciduous trees and shrubs). The north side of the house is “blocked” from winds by landscaping, fencing, or a garage or outbuilding.

The main living area contains as few partitions as possible to provide optimum air distribution and reduce the need for space heating and/or cooling.

A well designed ventilation system is in place. Attic ventilators are designed so air is drawn from under the home's eaves where it is cooler, and it is exhausted as high as possible through the roof outlets or attic gable ends.

Outside entries have a vestibule and space where entries can be closed off to prevent unwanted heat loss or gain.

## Interior Spaces

The interior design of the structure is just as important to a passive solar home as the exterior attributes.

The north side of the building is always the coolest. The east side is usually slightly cooler than the west, due to the combination of solar radiation and higher outside air temperatures from the afternoon sun. The south side of the structure has the overall highest temperatures because of the direct sunlight.

The rooms most frequently occupied are designed to take advantage of the home's solar potential. This typically includes the living room and kitchen/dining area. The main living area should incorporate as few partitions as possible to provide optimum air distribution and reduce the need for space heating and/or cooling.

Bathrooms, bedrooms, and other less frequented but occupied spaces are designed for the middle interior of the structure. Storage and utility spaces are designed for the north or northwest part of the dwelling.

Many passive designs include a buffer space on the north wall that might include storage closets, hallways or workshops. When possible, an attached garage on the north side is a suitable buffer space.

Homeowners can also take advantage of east/west sun position for “specialty” rooms. Many people enjoy southeastern exposure in the morning for bedrooms or breakfast nooks. The design might also include provisions for workshops or study areas that can take advantage of a southwestern exposure.



Windows with Shade Controls

## Key Characteristics of Passive Solar Design

Whether a new design or a retrofit, for a passive solar home to be effective, there should be five related characteristics in place. Each is dependent on the other and the home's heating effectiveness can be compromised if one or more of the elements is not in place. The elements are:

1. **Solar Radiation Apertures** – Windows and other glazing elements through which sunlight can enter the structure.
2. **Absorption Materials or Coating** – The dark surface of the storage element that absorbs the solar heat from the apertures.
3. **Thermal Mass** – The material that stores the absorbed heat. This material is usually masonry (stone, concrete, brick).
4. **Distribution Method** – A design and pathway for heat to move throughout the home. In some passive designs, natural heat transfer is augmented through the use of fans and blowers.
5. **Control Mechanism** – Controls that regulate the level of sunlight entering the home. These can either be built into the structure (overheads, awnings), landscaping, or controls such as blinds or shades.

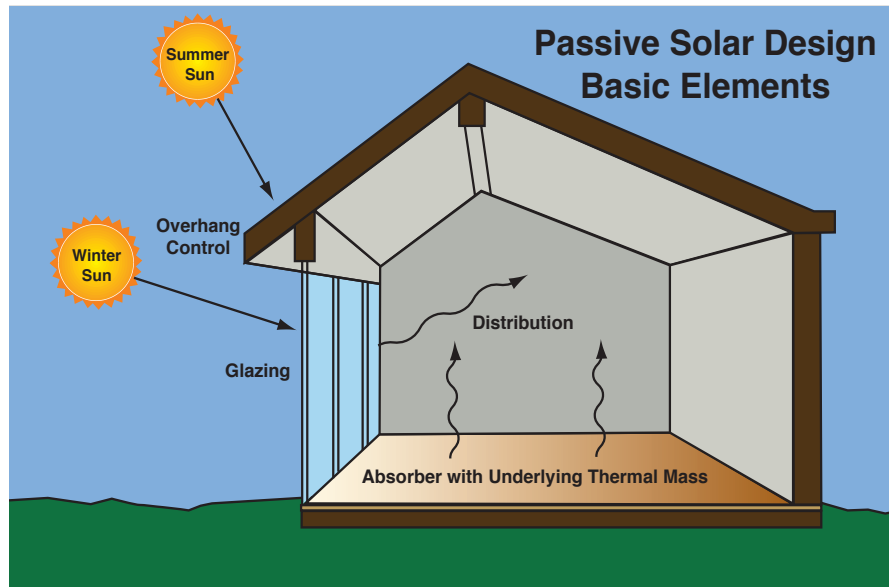

The synergy of all elements is critical. For example, materials such as carpeting do not store thermal energy well. Even though the house might have the proper window glazing and distribution design, the absence of adequate thermal mass (through improper materials) will negate the home's solar potential.

The following three passive solar design techniques take advantage of the five design principles. The difference is based on how these five elements are incorporated into each design.

## Direct Gain

If a home has south facing windows, it is impacted directly from the sun's rays through radiation, and the solar heat then becomes part of the convection cycle within the home. This is termed direct gain, and it is the easiest and most common passive design technique employed by solar designers.

In a planned and dedicated direct gain design, solar radiation enters through apertures such as south facing windows. It then contacts the absorption material/coating and is absorbed by the thermal mass beneath the material/coating.

Heat is transferred throughout the day and is also active at night, as the thermal mass within the house releases heat to attempt to warm the cooler objects and air within the home's interior through the principles of convection and radiation.

The amount of passive solar radiation that enters the home is called the passive solar fraction. The passive solar fraction is a computation of the area and type of glazing combined with the thermal mass. This is a critical component of direct passive design because the ratio of glazing to mass needs to be in balance or under or overheating can occur.

## Indirect Gain

An indirect gain design incorporates a dedicated thermal storage mechanism between the south facing windows and the home's interior. The most popular system involves what is termed a Trombe Wall.

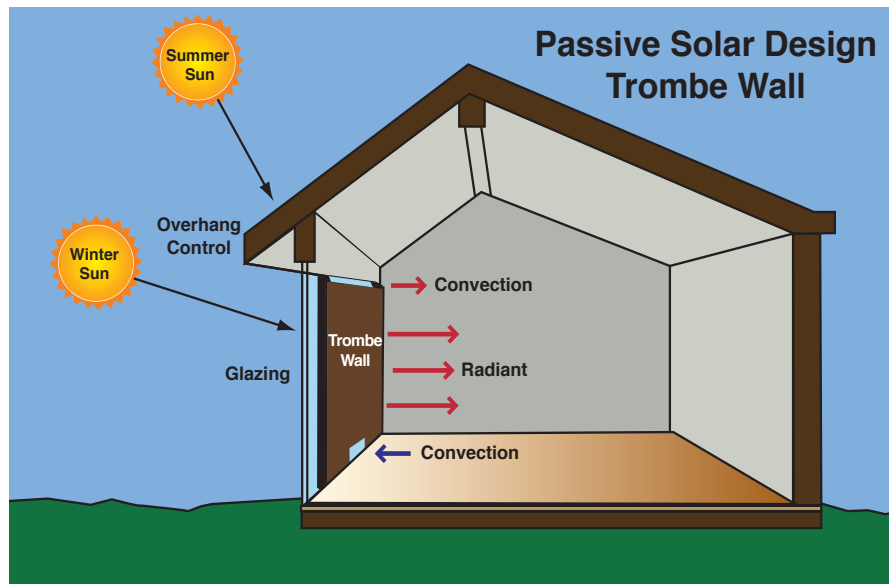



Trombe walls are typically constructed of 8-16" of masonry material that is coated with an absorber finish. The outside surface of the wall has either a single or double layer of glass mounted one inch or less from the wall's surface.

Solar radiation is transmitted through the glass, absorbed by the surface and stored in the thermal mass. The wall heats the home in two distinct manners. The first is through constant natural convection via openings at the top and bottom of the mass. Cold air passively enters through the bottom of the mass, passes between the absorber and glass, and exits into the room through an opening at the top.

The wall also heats the interior through radiation. As the home's interior temperature falls below that of the wall's surface, radiant heat is transferred. It is critical for radiant heat transfer that the wall's thickness and composition are designed to provide radiant heat when needed. Since heat travels through masonry at approximately one inch per hour, the thickness of the wall is critical in timing the passive heating of the home.

Controlling heat on Trombe walls is achieved by utilizing designed roof overhangs and/or outside coverings (for summer months). A well designed and constructed Trombe wall with effective controls is a viable and proven technology for Montana's climate. However, there is no "on or off" button in the system. Proper research and planning is critical in making this technology work to its potential.

## Isolated Gain

The third method of passive solar heating is termed isolated gain. This design uses a dedicated separate room or structure to collect and store solar radiation, which can then be transferred to a home's interior. The generic term for an isolated gain system is a solarium. Solariums are popular as an addition to an existing home and are available in a variety of designs and sizes.

Solariums involve the installation of an addition with vertical, south facing windows. The thermal mass within the solarium is usually a masonry wall or floor (or both). Water containers are also used as the thermal mass within the solarium.

Distribution within the solarium to the main house is usually accomplished with vents, windows, doors or fans (or a combination). Most designs incorporate a definitive separation and control between the solarium and home to prevent the home's interior temperature from fluctuating in response to the temperature of the solarium.



Solarium on Farm House

Solariums have the possibility of both extreme heat gain and loss, and glazing on horizontal surfaces should be designed and constructed properly. Many kits incorporate designs with glazing on both horizontal and vertical surfaces. These are not usually recommended for Montana's climate and if used, must incorporate measures to deal with snow loads.

Because of the low nighttime temperatures realized in Montana's environment, homeowners should also balance solar heat gain with emissivity when choosing glazing materials.

## Passive Solar Windows

Windows provide the easiest and one of the most effective opportunities for direct gain, passive solar. In colder climates like Montana's, the strategy for utilizing the passive technology is a combination of reducing heat loss and utilizing solar radiation for heat.

Before discussing new window technologies, passive solar benefits, and limitations of specific glazing materials and window types, it is important to first consider window placement.

Window placement is critical. The strategy for passive solar window design in northern climates is called "suntempering." A building that is designed to be "suntempered" incorporates south facing windows whose total square footage combined can add up to 7% of the building's floor area. Additional south facing windows can be added if dedicated thermal mass is built into the home.

As important as the inclusion of south facing windows is the minimization of north, northwest, and northeast windows, while still considering allowing enough light into those parts of the home.

The methods of heat transfer (conduction, convection and radiation) are critical to window design and effectiveness. Windows can account for approximately 30% of heat loss, and depending on the time of year, they can account for up to 75% of the home's total heat gain.

It is also important to consider that a considerable amount of heat is lost through a window's frame. The best choices in frame material are materials such as wood and vinyl that have low conductivity. If metal frames are used, they should include thermal breaks.

Quality window frames will also prevent condensation. Especially in remodeling, even the highest performing windows can experience problems with condensation if not properly seated in window frames or sashes.

## Heat Transfer at the Window Space

Conduction, convection and radiation are all major factors in the overall effectiveness of windows in the heating and cooling cycle of the structure. Naturally, infrared solar radiation entering through the window is the primary source of heat transfer, but there is much more at play than this.

There is significant conduction that occurs with windows and frames because the outer surface of the window is significantly colder or warmer (depending on the season) than the inside of the window. When the temperature outside is colder, there is constant molecular action to try to warm the outside surface; likewise, when the outside glass and frame are being warmed by the summer sun, the heat naturally conducts toward the cooler inside surface.

Conduction also occurs within the air spaces between layers of glass. The amount of heat transmission resulting from conductivity in windows due to temperature difference is called the "U-value" or "U-factor." The smaller the value, the less heat is transmitted.

Convection currents originated by windows are significant causes of heat loss and gain, especially in homes with a large amount of older or low quality glazing.

## Window Technologies for Passive Solar

Today's high quality windows can have as much as four times the insulation value when compared to windows manufactured ten years ago. The science and focus is no longer on adding additional layers of glazing to promote efficiency, but rather the improvements are being made in the window fill, coatings, edge spacing, and sash construction.

Double glazed windows are the most prevalent found in homes built (or retrofitted) during the last century. Triple glazing was also available and popular, especially in the 1980's and 90's.

Space between surfaces in double pane windows was also increased in the same time period. This boosted the insulation value but also created problems when the gap was increased from the typical ¼" to ½" to one inch or more. In some cases, this resulted in a convection cycle within the window itself and was counterproductive.

## Choosing Windows Based on NFRC Ratings

The National Fenestration Rating Council (NFRC) was developed as a non-profit collaboration of window manufacturers, building trade associations, and government agencies. Its purpose is to establish a fair, accurate and objective determination of a window's energy rating. The NFRC rating also applies to glazed doors and skylights. ENERGY STAR® qualification is based on the NFRC ratings.

If designing a passive solar home or planning a remodel, it is critical to understand the NFRC ratings and the options and differences of specific windows. For example, installing windows on the south side that are designed to block solar heat gain will defeat the purpose of the design.

## NFRC Ratings -U-Value or U-Factor

U-factor or U-value measures the rate of heat transfer through a product such as a window. It is different than R-Value, which is a measurement of a product's resistance to heat loss. The primary reason that R-values cannot be used in glazing is because of the constant interaction with direct radiation from the sun and their "purpose" in allowing both light and heat in to the home. R-values are measures of conductivity alone, while U-values include both convection and radiation.

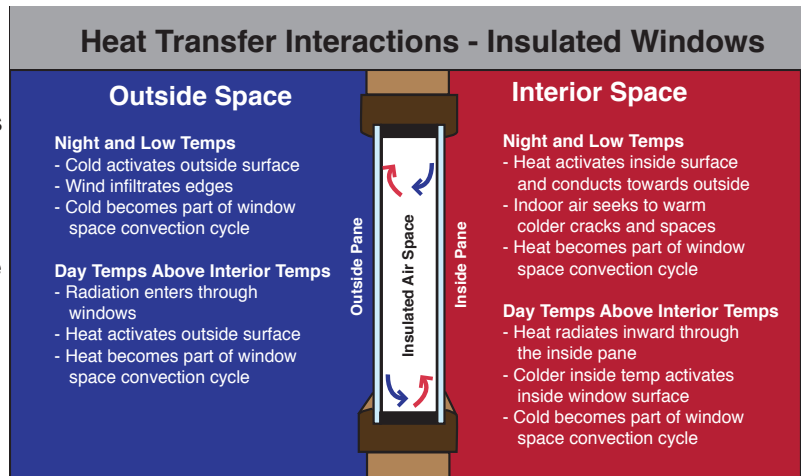

U-factor ratings generally range from 0.20 to 1.20. Most experts agree that windows with a U-factor of 0.40 or below are considered “energy efficient.” The lower the U-factor, the better the window is at keeping heat in. The U-value is especially important during the winter months.

Many of today’s windows are coated with a low emissivity (low e) coating to improve the U-value. Emissivity is the ability of a material to absorb specific types of energy, particularly infrared, and radiate that energy through itself and to the outside. Clear glass has high emissivity and will transfer approximately 85% of the infrared energy contacting it (from the inside) to cold air outside.

## Solar Heat Gain Coefficient (SHGC)

SHGC measures the effectiveness of the window in blocking heat from the sun. It is enumerated as a number between 0 and 1. The lower the number, the more effective the window at blocking solar radiation. For example, a number of .50 notes that 50% of the solar radiation is blocked and 50% is absorbed.

Consumers designing a passive solar home are often faced with the predicament of meshing glazing with an effective U-value and adequate SHGC. Typically, glazing with a desired U-value also rejects the majority of solar gain. In Montana, professional designers suggest a number of measures that can provide substantial benefit in the proper fenestration for passive solar heating and insulation.

**North facing windows should be kept to a minimum and benefit more from an effective U-value than a high SHGC coefficient. SHGC on the north side has little benefit, if any.**

**East and west facing glass should have a low SHGC (less than .40).**

**South facing glass should have a high SHGC with a inter bias. A proper overhang needs to be in place to prevent summer sun and capture the lower winter sun. If an overhang on a retrofit isn’t possible, thermal shades are another option, but these require manual operation and attention by the homeowner.**

## Visible Transmittance (VT)

Visible transmittance measures how much light comes through a window. It is important to consider that VT is strictly optical. VT is denoted by a number between 0 and 1, and the higher the number the more light that passes through.

## Air Leakage (AL)

AL measures how much outside air comes into a home through the window assembly. It is an optional number and many manufacturers choose not to include it on the label. This is because of other variables thought to be more conducive to infiltration, such as improper installation and the seal between the window frame and structure. AL ratings can be from 0 to 1. The normal range is between 0.1 and 0.3. The acceptable industry standard is 0.37.

## Condensation Resistance (CR)

CR is a measure of the effectiveness of the window in resisting condensation. CR is also an optional rating, and as with AL, factors such as installation and structural interfaces are considered high risk factors for condensation. CR is measured between 1 and 100. The higher the number, the better the product will resist condensation.

# Solar Heated Air Systems

## Overview

Although passive solar design is the usual choice for solar air heating of a dwelling, dedicated solar heated air collectors can be combined with a passive solar design or can serve as stand alone units for space heating. They are often used to augment traditional heat systems in older buildings where it is not practical to change out windows or make extensive changes to the building’s fenestration.

Solar air heating systems can be quite simple and inexpensive to either purchase or construct. Basic window mounted systems were popular in Montana during the 1970s and 80s and are still in use today. There are also a number of solar air kits and construction plans available to consumers.

Air systems are only meant for space heating and will not work for water heating. Domestic water applications require high temperatures that cannot be reached by common solar heated air units.

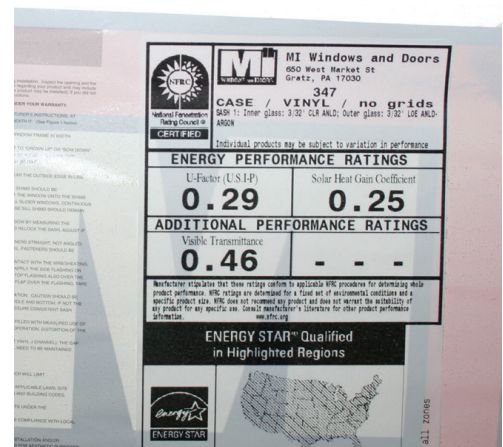

NFRC Ratings on a Window



## Solar Heated Air Collectors

Air heating systems usually employ a flat collector with an absorber substance around which air is circulated and then vented into the building's interior. Depending on the brand and design, the heated air can enter through dedicated openings or through portable means. One popular design has an entry port that is installed in a south facing window much like a portable air conditioner (and the unit is easily removed during the summer).

The most common and economical type of air system in use today is an air heating system that takes inside air, runs it through a collector unit where it is heated, and then vents it back inside the building. These are sometimes referred to as "dump systems." They are quite simple and usually involve only a collector, blower and minor duct work, but they possess no storage capabilities.

Dump units are usually mounted on the side or roof of a structure. The newest models are low-profile and can be combined in parallel. Controllers are also available to help coordinate the heat output profile between the collector and traditional heating system.

In order for the solar air system to be economical and save energy, it must be sized and positioned to take advantage of passive heat transfer within the home. If the house is not designed for passive heat movement, a dedicated transfer system (blower, directional fans) will be required, even if the unit is sized to provide a large amount of heat.



DIY "Soda Can" Portable Air Collector

## Transpired Collectors

Transpired collectors are rapidly gaining in popularity, especially in industrial applications. These industrial systems are designed for buildings that require a significant amount of make-up air. Transpired solar air collectors are usually comprised of perforated metal clad material. A fan is utilized to pull outside air through the perforations, where it heats up between 20 -90 degrees F. above ambient air temperature.

The fan then directs the pre-heated air into the building's existing heating/ventilation system, which results in the heating equipment having much warmer air to bring up to the required internal temperature for the structure.

## Solar Heated Air "Dump" System

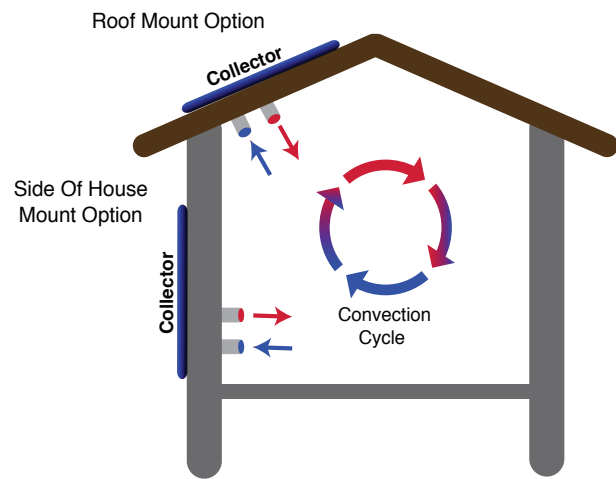

## Solar Hot Water Systems

### Overview

Solar hot water heating, whether it be for an end use of domestic hot water or space heating, is one of the most practical and cost-effective ways to incorporate renewable energy into a home. There are a variety of sizes and options for hot water heating applications, ranging from smaller, economical systems that supplement domestic hot water to large, elaborate units designed to service the majority of both the home's domestic and space heating needs.

Whether it be solar hot water or hot water space heating, all solar hot water systems have three main components: a collection system, a storage system, and a distribution system. The following section of this publication will provide an overview of the technologies and end use applications available to consumers.

### Flat Plate Collectors

Flat plate collectors are the oldest and most recognized solar hot water collectors on the market for both domestic hot water and space heating applications. They are adaptable to a variety of environmental conditions, handle extreme low and high temperatures, and shed snow well.



Solar Hot Water Collectors (Middle) Mounted Among Solar Electric Modules



Flat plate collectors are rectangular shaped and are commonly sized at up to 4'x8' feet and 4" to 12" deep, and a variety of sizes are available. The shell of the collector consists of an insulated frame with a solid back and a glazed front. An absorber plate sits directly underneath the glazing.

The interior of the collector consists of a series of copper tubes fitted to the absorber. Commonly, the tubes run parallel and are connected at each end to the inlet and outlet manifolds. Collectors can be joined together in a group to service greater hot water demands.

The absorber plate is the "black surface" that can be distinguished underneath the glazing of the collector. The industry standard for the absorber is a selective surface comprised of black nickel. This is the most efficient absorber material for both absorbing solar energy and converting it into heat, as well as preventing heat loss caused by "re-radiation," which is a reaction that decreases efficiency with a simple black painted surface.

Quality manufactured and installed collectors account for the impacts and pressures of environmental factors such as high winds on the collectors. They use design and materials that are rated for specific wind loads. Extruded aluminum frames are popular and have fastener connections around the entire collector, allowing maximum contact with the roof surface. These collectors come with compatible roof fasteners that are both strong and corrosion resistant.

Flat plate collectors can be roof mounted, ground mounted, or mounted to a vertical wall. Although roof mounted systems are the most prevalent, all types will work. Because of weight and wind loads, it is extremely important to match mounting hardware to the collector and prevent shortcuts in the mounting of the units.

There have been numerous improvements and alternatives for glazing surfaces for collectors, but the experts still favor low-iron tempered glass. This glass is designed specifically for collectors and has integral patterns on the outside to increase absorption and reduce glare. Tempered glass is very fragile on the edges and a rubber gasket protects the edges during installation.

## Evacuated Tube Collectors

Evacuated tube collectors come in a variety of designs and operating parameters. However, they all can be recognized by the presence of a number of individual glass tubes. Each tube contains an annealed glass covering and an absorber plate within the tube.

A vacuum is created inside the tube during the manufacturing process. This vacuum creates a significant insulation level which allows the absorber plate to reach higher temperatures.

The majority of newer evacuated tube collectors use heat pipe technology. There is a copper heat pipe integral to the evacuated tube and held in place by heat transfer fins (thin pieces of metal). Because the heat pipe is under a vacuum, the liquid inside of it boils at a much lower temperature.

Upon boiling, the vapor rises to the top of the heat pipe, which is contained within the collector's header and contacts the heat transfer fluid (usually a glycol mixture), where it rapidly heats up the transfer fluid.

The different designs among evacuated tube collectors includes systems that have integrated heat exchangers, specially formulated solar "liquid" contents, and varying direct conduction designs from the tube to the attached metal rods. New designs and components relative to the evacuated tube collector technology are consistently entering the market.

## Solar Flat Plate Hot Water Collector Design and Components

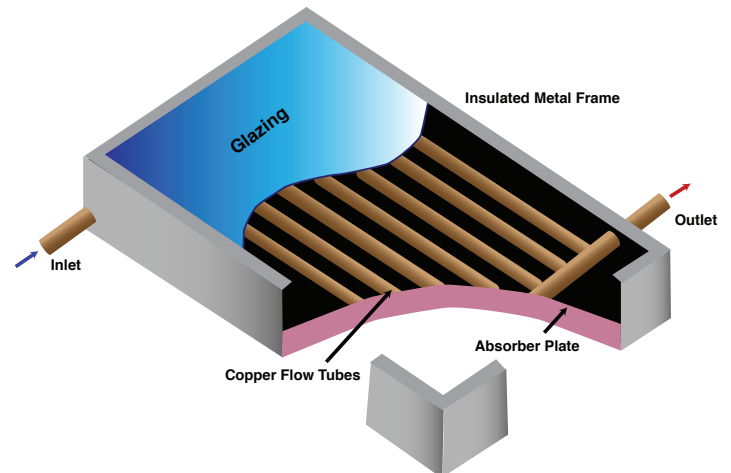

## Evacuated Tube Solar Hot Water Collector Design and Components

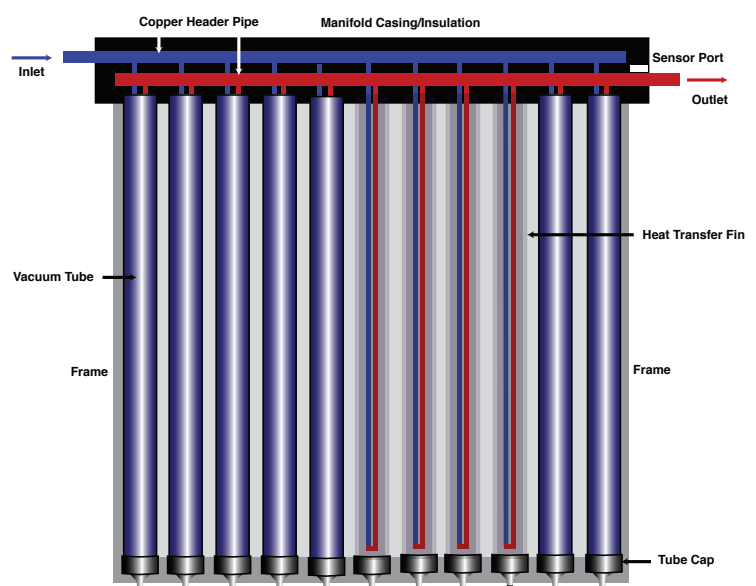

For Montana applications, the primary concern to date is that evacuated tube collectors have irregular surfaces and high internal insulation. Consequently, snow sometimes gets packed into the collector, and scraping it out has the potential to damage to the unit.

### Advantages/Disadvantages (Flat Plate vs. Evacuated Tube Collectors)

Flat Plate Collector (Advantages)	Evacuated Tube Collector (Advantages)
Better overall solar “yield” per square footage	Lower cost
Minimal thermal loss at the collector	More easily integrated into building designs and coverings
More stable in high winds	Fewer problems in areas with heavier snow fall
Perform better in low light and colder conditions	Readily available in DIY kits and designs
Capable of achieving higher operating temperatures	Temperatures for residential use are optimum



Flat Plate Collector



Evacuated Tube Collector

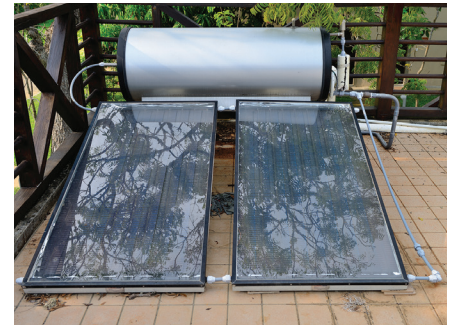

Solar Batch Heater

### Solar Batch Collector/Heater

There are other collector types available and being marketed to consumers. One of the most popular types is a solar “batch heater.” These units feature a tank or vessel contained in an insulated, glazed box or a design with a storage tank sited adjacent to or “on top” of the collector.

Solar batch heaters work by allowing the sunlight that is concentrated through the glazing to be absorbed and directly heat the end use water. These systems will work for portable, seasonal applications, but are not recommended for primary residential use. They have limited freeze protection and controls and will not work in year-round Montana applications.

### Hot Water System Choices for Montana

Montana’s climate requires that substantial freeze protection for the solar water system be provided, both at the collectors and within the storage/distribution system where freezing temperatures can occur.

It is not practical to use domestic or distilled water as the solar fluid in Montana applications. The best choices are systems that employ freeze protection provided by the use of a dedicated solar fluid, usually a propylene glycol mix.

Because of the need to use a chemically enriched fluid, Montana systems should be indirect and closed-loop. In most systems, the use of a dedicated solar fluid also involves the use of pumps and controls, so the systems would also be considered active.

This publication will highlight the three most common designs (two active, one passive) that employ solar fluid in an indirect, closed-loop system. The most utilized by Montana solar heat professionals is a closed-loop antifreeze system.

## Indirect Thermosiphon Systems

Indirect thermosiphon systems take advantage of the fact that hot water rises naturally. They can also effectively utilize a freeze protected solar fluid. The solar fluid, which is heated by the collector, rises to the storage tank where it transfers heat to domestic or space heating water via a heat exchanger. As the fluid transfers the heat and cools (in the heat exchanger), it exits through the bottom of the exchanger and is re-circulated through the collector.

Indirect thermosiphon systems are effective, simple in design, and don't require pumps or extensive controls. Their limitations are based on the required design element that the heat exchanger and solar tanks need to be placed above the collector units. This presents both a structural and aesthetic issue for roof mounted units, as well as the need for the storage unit to be in a freeze-protected environment.

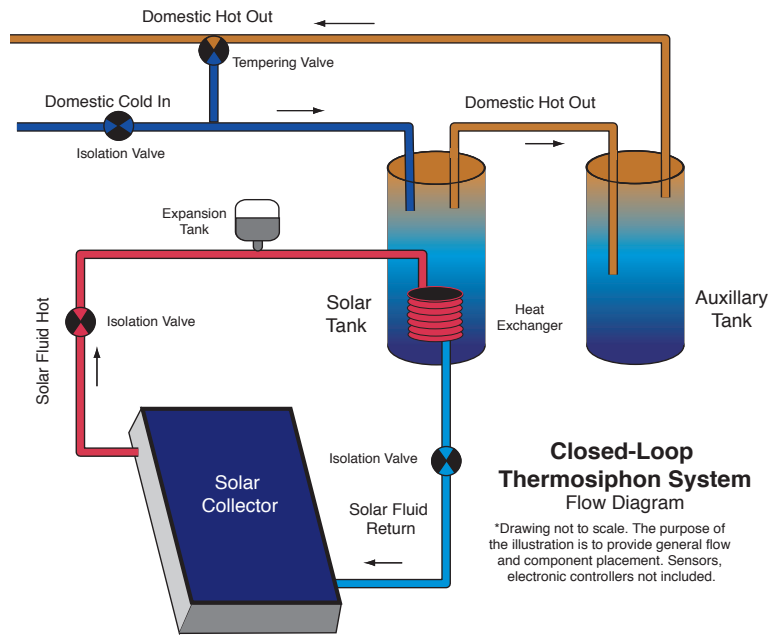

Traditionally, utility rooms are located in the basement or first floor of homes. In the case of a leak or busted pipe, this is a valid precaution in preventing damage to the entire home. A water storage unit on the second or third floor of a framed home is not recommended in most cases.

Indirect thermosiphon systems, given the right building design, can be effective and work quite well. However, as additions or in most traditional building designs, the added risk and storage requirements increase.

## Indirect Drain Back Systems

Indirect drain back systems are an option for Montana consumers. However, caution is warranted because of the susceptibility of these systems to severe or continuous cold conditions. In order for an indirect drain back system to function through negative temperatures, glycol is added to the closed loop.

Drain back systems are indirect, closed-loop, active systems that are designed to take advantage of the use of pure or minimally altered (with glycol) water as the solar fluid. The system works by allowing the unit to shut off when the desired temperature is reached in the storage tanks (high limit). At this point, the closed-loop solar fluid drains out of the collectors into a drain back tank. Because of the "automatic" shutdown capabilities when there is no demand, drain back systems are popular and very convenient in applications where the heat load is not consistent.

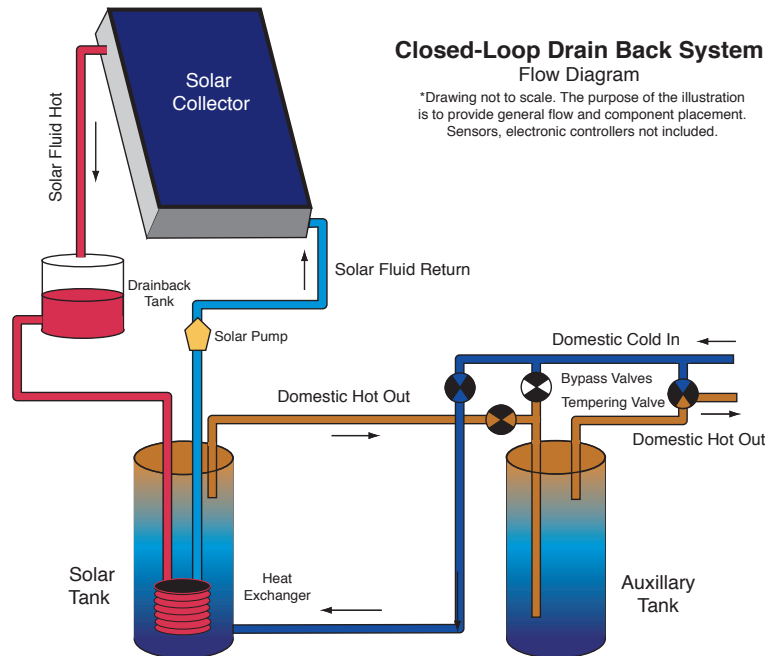

The collector(s) must be located above the drain back tank for the system to work. The size of the systems is also limited by the size (and space required) for the drain back tank. For the system to work properly, the pumping and control systems, along with the mounting and piping components, must be fine tuned and exactly to specifications.

Drain back systems are a good choice for many applications and are one of the three most popular systems in the United States. However, if glycol isn't added, even a small amount of retained water exposed to freezing conditions can cause damage to the system.

## Closed Loop Anti-Freeze Systems

For seasonal freezing and extended periods of cold weather, closed-loop anti-freeze systems are the solar thermal design of choice. They can be applied to either domestic or space heating applications and are designed for a wide variety of heating loads.

Closed-loop anti-freeze systems are also called pressurized glycol systems. They are active, indirect and closed-loop. In the systems, a glycol/water mixture circulates from the collector to a heat exchanger in the solar tank, and then is pumped back through the collectors. The domestic water is heated through the thermal interaction within the solar tank.

Closed-loop anti-freeze systems require several auxiliary components for adequate system operation. These include an expansion tank and a separate (but small) pumping system to circulate the fluid through the closed-loop when the temperature controller requires heat for the domestic water. When heating is complete, the closed-loop controller shuts off the pump and the fluid in the closed loop is stagnant.

The one significant downside to the systems is overheating and degradation of the fluid when the system is idle. Because the optimum mix for the solar fluid cannot be overloaded with glycol (or it creates problems for the pumping system), a specific fluid composition needs to be maintained to ensure against overheating and corresponding failures. Closed-loop solar systems are the most vulnerable on hot, sunny days with little heat demand.

Many homeowners opt for a shunt load add-on for larger systems. This allows the system to continue operation during periods of high ambient temperatures and solar radiation. The heated water is diverted to applications including hot tubs or portable greenhouses.

Closed-loop anti-freeze systems are available in complete kits, and they are recommended for consumers. Because the systems are pressurized, it is important that all components are sized properly (and included). This includes measures for air venting and maintaining the proper charge on the system, as well as controls to prevent unwanted thermosiphoning.

## Common System Components

No matter what type of system a consumer purchases and installs, a number of key components will be required to complete the installation. Each type of system requires materials, controls and components specific to the individual design, but there are elements applicable to nearly all system types.

## Solar Hot Water Storage Tanks

Solar hot water storage tanks are available in a variety of sizes ranging from 40 to 120 gallons. They can either be constructed of lined steel or fiberglass. Steel tanks are encased in insulation, which is then protected by another thin layer of steel.

Fiberglass tanks are relatively new additions to the solar thermal industry. Constructed using a fiberglass vessel and outer composite jacket, they do not deteriorate or rust and have good insulating properties. The primary issues with the tanks are those caused by incompatibilities with metal fittings and damage caused by inward pressure when the tank is drained and a vacuum is formed.

Consumers should never use plastic or rubber lined tanks for solar thermal applications. These materials cannot withstand the temperatures reached in solar applications, and they can be expected to have a short life span.

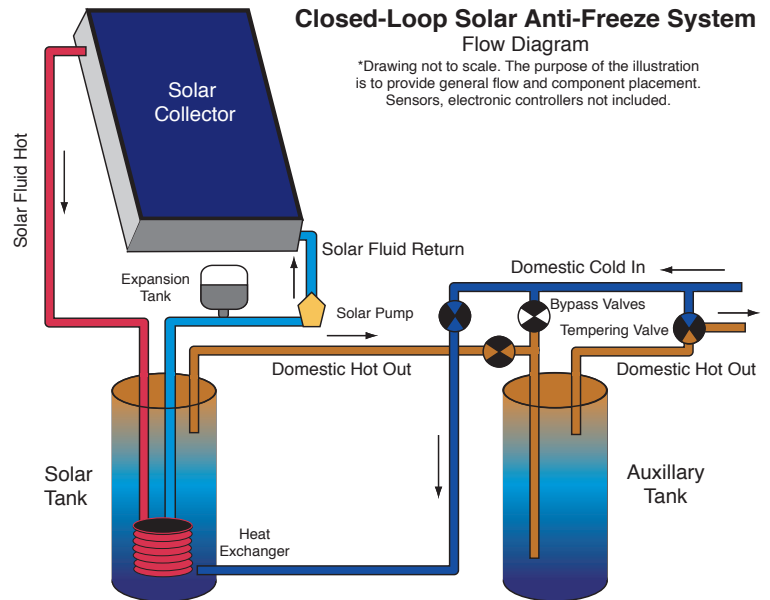

Custom Solar Hot Water Tank



## Heat Exchangers

Liquid to liquid heat exchangers transfer the heat from the solar fluid to domestic water. They allow the two fluids to pass next to each other and the heat is transferred via a conductive membrane from the solar fluid to the domestic hot water.

Heat exchangers are constructed either of pipes or plates, and they can be either single or double-walled. Single-walled exchangers are the most efficient and practical for residential applications. Some municipal codes require a double-walled exchanger to prevent the contamination of domestic water from a leak on the solar fluid side of the exchanger.

## Pumps

The typical pump used in solar water heating systems is a 120 volt AC pump. The function of these pumps is to circulate the solar fluid between the collector and storage tank. It is imperative that the pump matches the design and demands of the system.

DC pumps can also be used and can be purchased in two configurations: brush or brushless. DC pumps are either powered by a twelve volt supply or directly from a solar PV panel (which is a design feature gaining popularity).

If using a DC pump, the pump has to have the capacity for enough linear current to start the system quickly. This may require a linear current booster (LCB) between the DC power source and the pump.

## Pipe and Insulation

Because of the wide variety of temperatures in the solar loop, pipe composition and insulation are critical for performance and integrity. Copper pipe and tubing are usually the material of choice due to their availability and ease of use.

Experts caution that only copper pipe or tubing should be used for the hot water supply side in the solar loop. There is a type of tubing called PEX (cross-linked polyethylene) that can be used for potable water lines on the return side, however some professionals question the durability and longevity of the material.

High temperature pipe insulation is a requirement for the solar loop, otherwise considerable heat will be lost in transit rather than being available for the end use application. For inside applications, fiberglass or foam pipe insulation works well, but it will not work on outside runs because it soaks up moisture and loses its insulation value.

For outside runs, a specialty insulation like HT Armaflex® is the appropriate choice. Many installers also add PVC or aluminum jacketing material to prolong the life and productivity of the outside insulation.

## Solar Loop Fluid

For the heating loop in a solar hot water system, propylene glycol is the anti-freeze fluid of choice and the industry standard. It is considered non-toxic and retains its stability through extreme temperature variations.

There are propylene glycol mixes made specifically for solar heat applications and labeled as such. These have additives to prevent breakdown and are compatible with solar heat components.

Propylene glycol is always mixed with a certain amount of water; in no circumstances should it be used at 100% strength. The water-glycol mix should provide freeze protection at least 10 degrees below the noted lowest ambient temperature. Glycol based solar fluid has an approximate life expectancy of 10-15 years. It should be checked periodically, especially after extended idle periods and abnormally high temperatures.

New to the market are plant based glycols, which are non-toxic and considered food grade. These fluids have performed well in a variety of applications.

Consumers should avoid DIY website recommendations that advocate the use of fluids such as bray oil. A number of these types of oil are caustic and potentially flammable.



Solar Hot Water Components

## Isolation and Tempering Valves

An isolation valve needs to be included in solar hot water systems in case of an emergency or maintenance problem, while still permitting the backup water heater to remain operational. The isolation valve is manually operated and is placed on both the ingoing and outgoing water lines. Isolation valves can also be used on the backup heater to take it off-line during periods when only the solar thermal heater is required.

A tempering valve should always be included in the system, as it is critical to the safety and performance of a solar hot water system. The valve is plumbed at the end of the loop, before the water flows to the end use application.

Tempering valves automatically add cold water to the domestic system and can be set to a predetermined temperature. Most tempering valves are activated when the solar heated water is above 120 degrees Fahrenheit, but the trigger point for tempering can be set at a higher temperature.

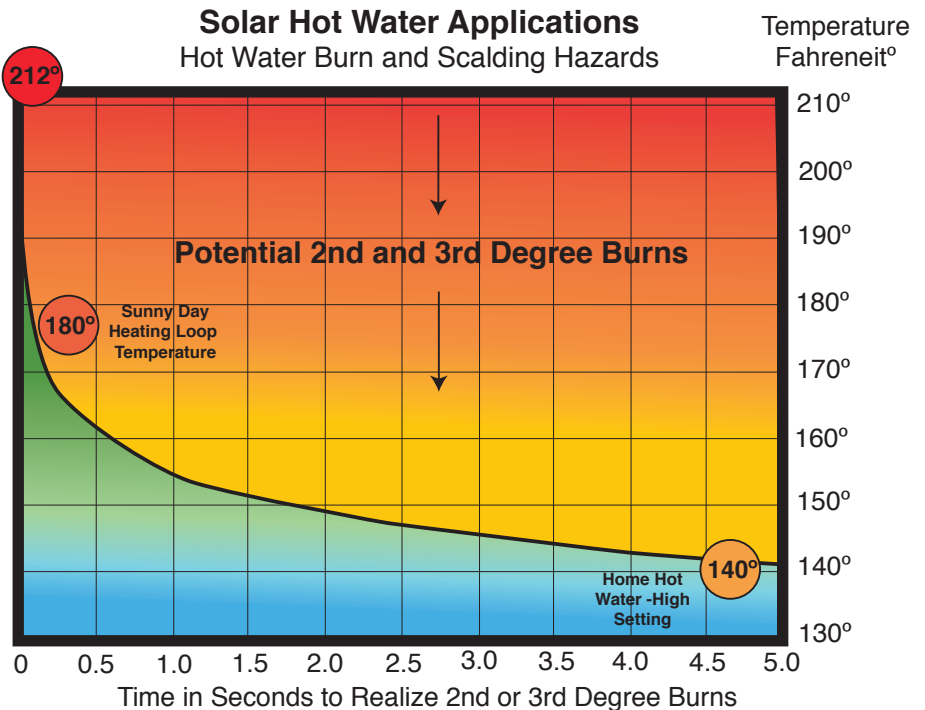

## Available Tax Credits/Financing

### Federal Residential Solar Hot Water Heat Tax Credit

The Federal Energy Policy Act of 2005 established a 30% tax credit for the purchase and installation of solar hot water heating systems (excluding swimming pools and hot tubs). To be eligible for the credit, the system MUST be certified for performance by the Solar Rating Certification Corporation (SRCC).

At least one-half the energy used to heat the dwelling's water must be from the solar heating system. Covered expenditures include installation costs, site preparation and piping to connect the system to the home. This credit is slated to expire on December 31, 2016.

The tax credit applies to the net cost remaining after the Montana Alternative Energy Systems Credit has been taken. For example, a \$6,000 system that received a \$1,000 joint state tax credit would be eligible for a credit of 30% on the remaining \$5,000. This would equal \$1,500.

### Montana Alternative Energy Systems Tax Credit

The Montana Alternative Energy Systems Credit is a tax credit applicable to income tax liability for the cost of purchasing and installing a variety of solar heating applications, including passive solar, solar domestic and space water heating.

The credit is limited to \$500 per individual who owns the home. If the home is owned jointly by a couple, they may each claim \$500 (\$1,000 total). An unused balance on the credit may be carried over for a period of four succeeding tax years.

### Montana Alternative Energy Revolving Loan Fund

The Montana Alternative Energy Revolving Loan Program offers consumers low-interest loans of up to \$40,000, with a repayment period of ten years. The loans are subject to the availability of funding.

Energy conservation measures that support the solar heating application can also be included in the funding request. All projects must be located in Montana and generate heat for the occupant's use.



Funding for the printing of this publication has been provided through Universal System Benefits (USB) funds collected from NorthWestern Energy customers.

## **The Montana Consumer Guide to Solar Heating Systems**